

# STAR

---

## USER MANUAL

---

Model Star 51 Latching Handset

**Star Universal (Gosport) Ltd**

Unit 2, Clarence Wharf, Mumby Road, Gosport, Hampshire, United Kingdom, PO12 1AJ

Tel: + 44 (0) 23 9258 2857 Fax: + 44 (0) 23 9251 1731

Email: [sales@staruniversal.com](mailto:sales@staruniversal.com)

Web: [www.staruniversal.com](http://www.staruniversal.com)

Star Universal (Gosport) Ltd  
Unit 2, Clarence Wharf  
Mumby Road  
Gosport  
Hampshire  
PO12 1AJ  
Telephone Number: 023 9258 2857  
Fax Number: 023 9251 1731  
Website: [www.staruniversal.com](http://www.staruniversal.com)  
Email: [sales@staruniversal.com](mailto:sales@staruniversal.com)



---

All rights reserved. Nothing from this edition is allowed to be copied and/or made public by means of print, photocopy or any other way without previous written permission of **Star Universal (Gosport) Ltd**

**Star Universal (Gosport) Ltd** reserves the right to change spare parts and/or specifications without previous notice. Contents of this manual can also be changed without previous warning.

**Star Universal (Gosport) Ltd** cannot be held responsible for eventual damage caused by specifications deviating from the standard model.

Although extreme care has been exercised during the writing of this manual, **Star Universal (Gosport) Ltd** will not accept any liability for eventual errors in this manual and/or for the consequences of (mis)interpretation of the contents.

**Star Universal (Gosport) Ltd** is not responsible for damage or problems which result from the use of other than the original spare parts.

If this manual has not been supplied with instructions for certain repairs, adjustments and maintenance, you should contact **Star Universal (Gosport) Ltd**

---

**Contents**

1	Introduction and check list	3
2	Safety	4
3	Connecting the Handset to the Power Pack	5
4	Handset Operation	5&6
5	Maintenance Calendar	6
6	Jaw Maintenance and Service Spares	7&8
7	Thermocouple Replacement	9
8	Jaw Assembly Diagram	10
9	Spare Parts	10
10	Wiring Diagram	11
11	Technical Specification	12
12	Environmental Policy	12
13	Warranty Policy	13

**1 INTRODUCTION**

With the purchase of this heat sealing machine you will be able to pack a great variety of products. **Star Universal (Gosport) Ltd** has ensured that all the machines, from the smallest to the largest model, fulfil the greatest demands. All the machines are built in-house to the highest standard and undergo vigorous testing.

**Unpacking**

The heat sealing machine is packed in either a box or pallet. We recommend you keep the box/pallet so you can transport the heat sealer safely in the future if ever required.

**Use the following list to check the contents of the box/pallet:**

<b>Manual</b>	✓
<b>Spares Kit</b>	
<b>Additional spares (if applicable)</b>	

## 2 SAFETY

### SAFETY INSTRUCTIONS FOR HEAT SEALER OPERATION



**WARNING** this manual should be read in full prior to operating this heat sealing machine. Ensure all the operators are aware of how to use it safely.

All users of this product are requested to follow all warnings and instructions contained in this manual. In addition, all warnings and instructions affixed to the machine should be followed.

The machine is not rated for direct water contact unless otherwise stated.

Ensure the power is switched off and the plug removed from the socket prior to carrying out any service work.

The machine should be regularly serviced using genuine Star parts and is subject to the portable appliance test regulations.

When not in use switch the machine off.

The sealer is designed to be installed on a flat level surface to ensure stability during operation.

Heat sealers are not designed to be used in flammable or explosive environments.

With repeated cycling residual heat can build up on the sealing jaws. Avoid touching them wherever possible.

Keep hands clear of the sealing jaws when operating the machine.

Always use heat sealers in a ventilated environment as sealing certain plastics may create fumes. Check with your bag/material manufacturer.

### SAFETY FEATURES

All Star heat sealers are built to minimise risk of any injury to machine operators and anyone who can come into contact with them. The main risks involved with Star heat sealing and the safety features built into the machines are:

**Sprung jaw:** After machine operation when releasing the latch the jaws are sprung to open. Operators should ensure they are clear of anything that may impact them.

**Heated sealing jaws:** The heating element and jaws may become hot with continued use. This temperature is low enough so as not to risk causing burns. The element ribbon is only heated to weld temperature when the jaws are fully closed. Warning labels are affixed to the jaws to advise operators to keep their hands clear.

**Exposed electrical terminal:** The only exposed electrical terminals are low voltage on a SELV circuit and pose no risk.

---

Star Heat Sealers meet the health and safety requirements of The Supply of Machinery (Safety) Regulations 1992 No. 3073 and The Machinery Directive 2006/42/EC. The CE mark will be affixed to the product where applicable.

A request is made that any known incidents that result in injury to an operator from the legitimate use of this heat sealer is reported to Star Universal Technical Department. Tel: 02392 582857 e mail: info@staruniversal.com

---

### 3 CONNECTING THE HANDSET TO THE POWER PACK

Before connecting the power pack to the electric supply the jaws or sealing head supplied should be connected to the power pack.

This power pack should only be used with jaws or sealing heads compatible with it. These jaws have been provided to work on Power Pack Serial Number: 000000/56

If you wish to connect a different set of jaws or sealing head to the above power pack please contact Star Universal with the new specification and power pack serial number so we can advise compatibility.

With the power pack turned off take the large 6 pin plug on the end of the cable and connect it to the socket on the back of the power pack. The plug will only fit one way round. Ensure the two catches are engaged to give a strong connection.

If there is a green thermocouple plug, plug this into the green socket on the back of the machine. The plug will only fit one way round.

### 4 HANDSET OPERATION

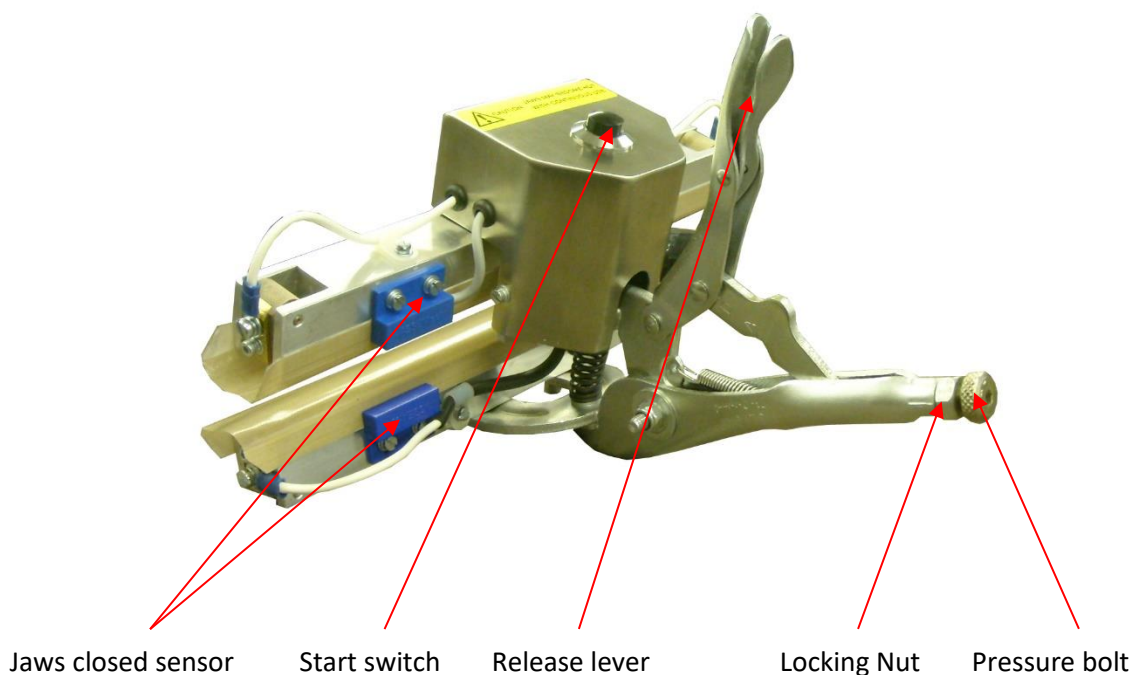

#### SETTING JAW PRESSURE AND SAFETY SWITCH

When closing the sealing jaws you should feel a firm 'click' over to the latched position. This can be adjusted. If the jaw closure is too tight release the locking nut and unscrew the tension bolt (anti clockwise). To tighten screw the tension bolt in (clockwise) and re tighten the locking nut. If the machine does not cycle when the jaws are closed and the start switch is pressed the jaws closed sensors may be too far apart. Loosen the two screws holding them onto the jaw and move closer together. Re tighten the screws.

**MACHINE OPERATION**

Once the weld and cool times have been set, along with the compensation if required, the sealer is ready to use.

The operation involves placing the material to be sealed between the jaws, squeezing the handles to shut the jaws and pressing the start button. The machine automatically runs through a weld and cool cycle. When the blue cool light goes out release the jaws by pressing the release lever up.

When opening ensure your fingers will not be pushed into the switch cover as the jaws are sprung. Also ensure you have hold of the handset to prevent it falling onto the ground.

When operating the machine ensure your hands or anyone else's are not between the jaws. Try and avoid touching the jaws if possible as they can become warm with continuous use.

**5 MAINTENANCE**



**WARNING! Unplug machine before any maintenance is carried out**

<b>DAILY MAINTENANCE</b>	
Visually check barrier tape	Change tapes if there are any burn marks, rips OR damage.
Jaws move freely	Before turning machine on, manually shut jaws and ensure they move freely.
<b>MONTHLY MAINTENANCE</b>	
Sealing jaws	Change tapes, element and rubber if necessary. Check end blocks are not damaged.
<b>6 MONTH MAINTENANCE</b>	
Repeat monthly maintenance	A 6-month maintenance kit can be ordered from Star Universal.
<b>YEARLY MAINTENANCE</b>	
Contact Star Universal	You can request an onsite visit or send the machine to <b>Star Universal (Gosport) Ltd.</b>

## 6 JAW MAINTENANCE AND SERVICE SPARES

Under normal operating conditions it will be necessary to replace certain expendable items that are readily available from our spares department. Use of non-Star genuine parts or the incorrect part number can cause damage to the machine and invalidate the warranty.

Before replacing any sealing jaw items ensure the machine is switched off and unplugged.

### Replacing consumable items

**Barrier Tape:** The barrier tape is a brown Teflon coated cloth designed to prevent plastic sticking to the element ribbon. If this becomes burnt or damaged peel the old tape off, removing any excess adhesive from the jaws. Take a length of new tape, remove one of the adhesive strips and stick it to the front of the jaw, remove the other adhesive strip and stick to the back of the jaw. **The tape should be applied loosely so it is not in contact with the element ribbon when the jaws are open.**



**Element Ribbon:** Remove the barrier tape as above. Place the loading pins through the expansion blocks and holes in either end of the jaw to keep the springs under compression and loosen the Allen key bolt. Remove the old ribbon. Cut a length of new element ribbon slightly longer than the jaw and fold one end back on itself by about 5mm. Place this end in one of the expansion blocks and tighten the Allen bolt. Measure the length of ribbon required to fit into the other expansion block, cut to length and fold the end back 5mm. Fit in the other expansion block and tighten the Allen bolt. Remove the loading pins and re-cover with barrier tape. **Ensure on double heat machines that the two elements line up to produce a good seal.**

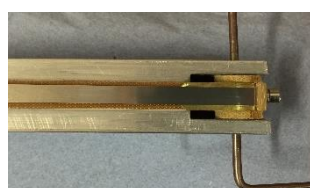

**Brass Shim:** Remove barrier tape and element ribbon as above. Remove the brass clamp by fully unscrewing the Allen bolt. Replace the brass shim, attach the brass clamp and re fit the ribbon and tape as above.

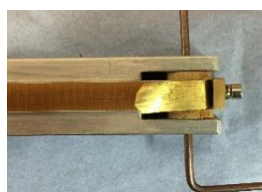

**Silicone Rubber/Sponge – Heated Jaw:** Remove the barrier tape and element ribbon as above. Peel the silicone rubber away from the aluminium sealing jaw and clean any residual adhesive left behind. Apply a NARROW bead of silicone adhesive to the channel, cut a piece of silicone rubber to length and press into the channel ensuring a smooth surface. Replace the sealing ribbon and barrier tape as above.



**Compression Spring and Ball Bearing:** Remove barrier tape and element ribbon as above, remove loading pin taking extra care due to the spring being under tension. Replace Compression spring and ball bearing. Refit element ribbon and tape as above.





## 7 THERMOCOUPLE REPLACEMENT

**Thermocouple:** If the silicone has been replaced cut a shallow V in it just deep enough for the thermocouple wire to sit flush with the rubber, the tip/disc should be sat on top of the rubber. Place the thermocouple through the hole and fasten in place with thermocouple adhesive strip. The tip of the thermocouple should be in the centre of the silicone. The backing tape should be applied to cover the thermocouple.

1. Cut V shape into rubber:



2. Place thermocouple through hole in jaw:

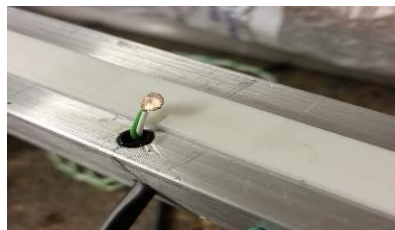

3. Secure thermocouple using the thermocouple adhesive strip:



4. Place backing tape over length of rubber and replace the element ribbon:

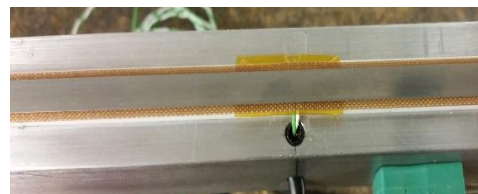

8 HEATED JAW TENSION ASSEMBLY

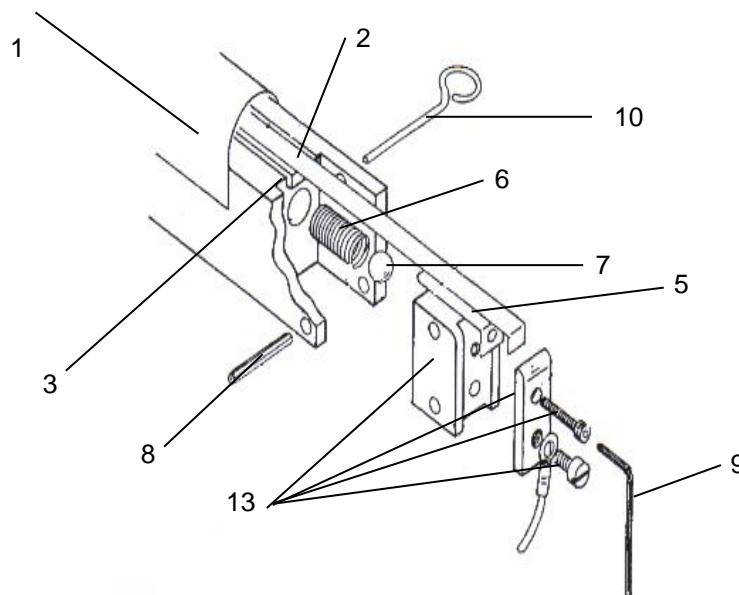

JAW ASSEMBLIES

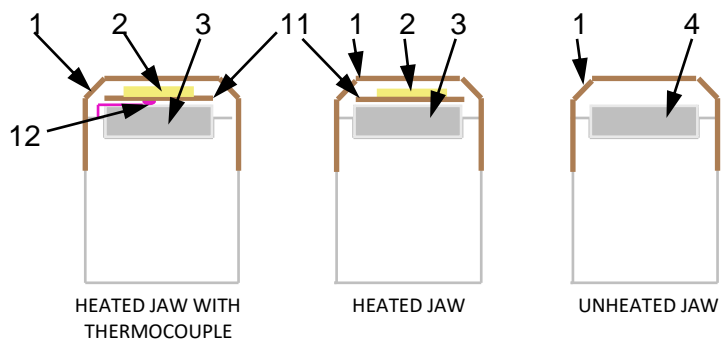

Part No	Diag No	Description
B018003	1	50mm Barrier Tape
E024002	2	6mm Element Ribbon
B017002	3	9.5mm Silicone Rubber
B017007	4	9.5mm Silicone Sponge
M202003	5	9.5mm Brass Shim
B021005	6	Compression Spring
B022002	7	Ball Bearing
B023002	8	25mm Roll Pin
B029002	9	Allen Key
M202009	10	Loading Pin
B018029	11	9mm S/A Backing Tape
E019006	12	Thermocouple
M202005	13	Pair 15.5mm End Blocks
B017014	NA	85g Silicone Rubber Adhesive
E013002	PLUG	6 Pin Plug
E013024	NA	Thermocouple Plug
E013025	NA	Thermocouple Free Socket
E011023	RS1	Jaws Closed Reed Switch
B021003	NA	Jaw Return Spring
E010017	SW2	Start push button

10 WIRING DIAGRAMS

STAR HANDSET

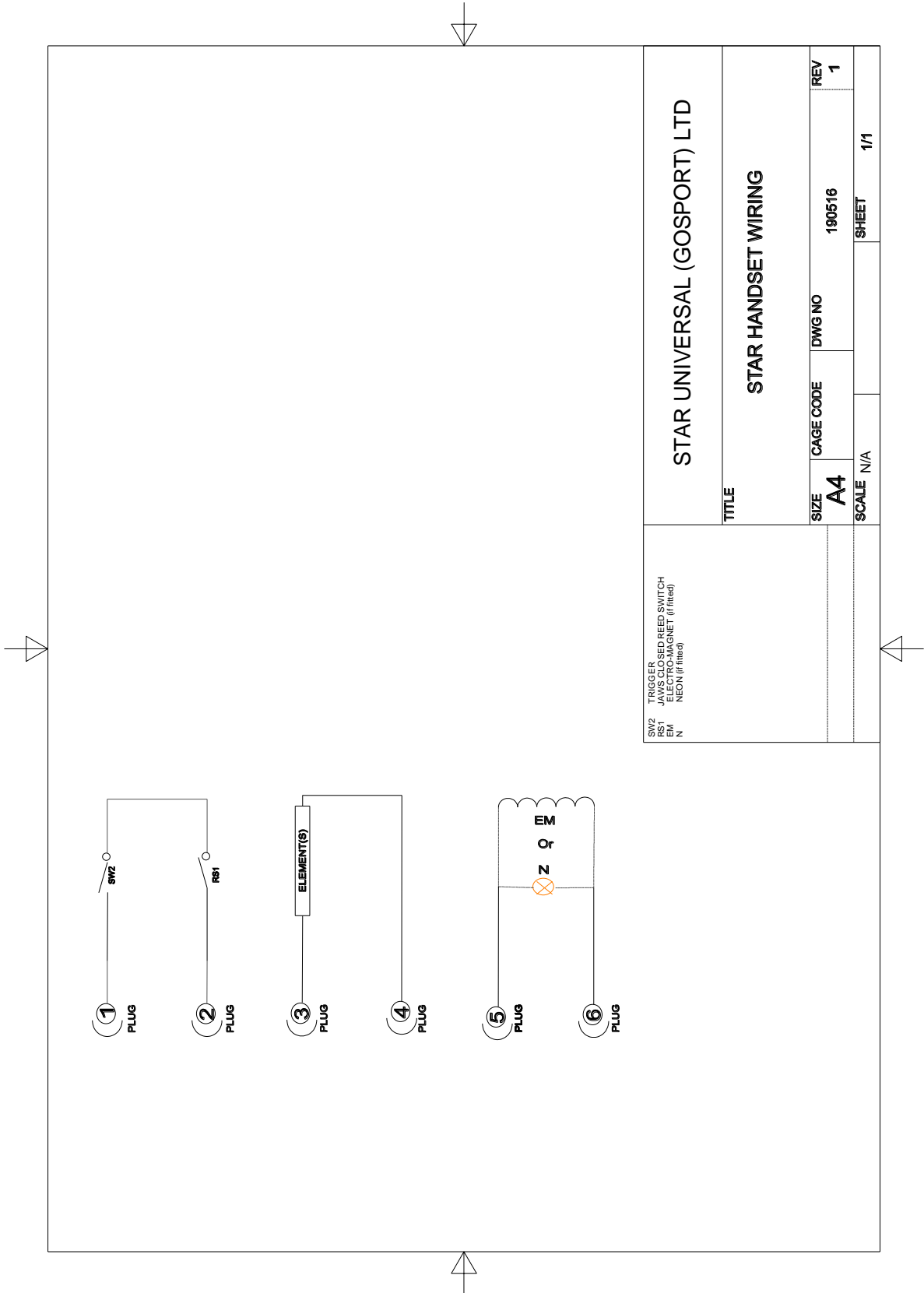

STAR UNIVERSAL (GOSPORT) LTD		REV	1
TITLE		DWG NO	190516
STAR HANDSET WIRING		SCALE	1/1
SIZE	CAGE CODE	SHEET	1/1
A4	N/A		
SW2 - TRIGGER JAWS CLOSED REED SWITCH RST - JAWS CLOSED CONTACT (if fitted) N - NEON (if fitted)			

**11 TECHNICAL SPECIFICATION**

Seal Length	150mm - 900mm
Seal Width	6mm Standard, 2.5mm, 9.5mm and 12.5mm options
Jaw Opening	25mm approx.
Max Material thickness	1000µm approx. (4000g)
Weight	5kg - 8kg

All the above weights and dimensions are approximate and based on the standard machine E&OE.  
 Star Universal reserves the right to change the above specifications without prior notice.

**12 ENVIRONMENTAL RESPONSIBILITY**

**MACHINE RECYCLING**



As this machine contains electrical and electronic components it must be disposed of correctly and not in general land fill.

As Star Universal only build industrial equipment to individual customer requirements the responsibility for the disposal lies with the end user.

Star Universal will offer a collection service for machines we have built at the end of their useful life for recycling.

Please contact us for prices stating the machine model and serial number.

Producer Registration No. WEE/MM7018AA

### 13 STAR UNIVERSAL WARRANTY POLICY

The Company provides a 1-year warranty from the date of delivery on all Star Heat Sealing machines. If any part is found defective due to faulty manufacture, Star Universal will affect the repair or replacement to the customer free of charge providing:

- a) The fault is reported directly to the Service Department.
- b) The fault is not caused by misuse, neglect or faulty adjustments by the operator.
- c) The machine failure has not occurred through normal wear and application usage.
- d) The machine has not been serviced or repaired by any person not authorised by Star Universal during the warranty period.
- e) The machine is returned to Star Universal at the address below.

Expendable items like the jaw barrier tape and heating elements are not covered by the warranty but are readily available at a charge from the Service Department.

Travel time to attend a machine on site may be charged at the current applicable rates.

This warranty is additional to the normal customer statutory rights.



**Star Universal (Gosport) Ltd**

Unit 2, Clarence Wharf, Mumby Road, Gosport, Hampshire, United Kingdom, PO12 1AJ

Tel: + 44 (0) 23 9258 2857 Fax: + 44 (0) 23 9251 1731

Email: [sales@staruniversal.com](mailto:sales@staruniversal.com)

Web: [www.staruniversal.com](http://www.staruniversal.com)